

-P1-

HANDLE WITH CARE

IMC 197

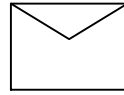
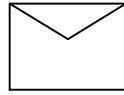

-P1-

HANDLE WITH CARE

IMC 197

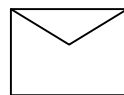
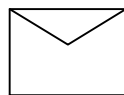

Pozn.: Tuto stránku tisknout na hnědý papír !

OBSAH VÝKRESU:

Papírová krabice

PROJEKT:

paleta Autopal Hluk

MĚŘÍTKO:

1:1

Č. VÝKRESU:

1/2

BOJ TRANSPORT
OSTROŽSKÁ NOVA VES
tel.: +420 737 42 3939
bojctransport.cz

Půdorys palety

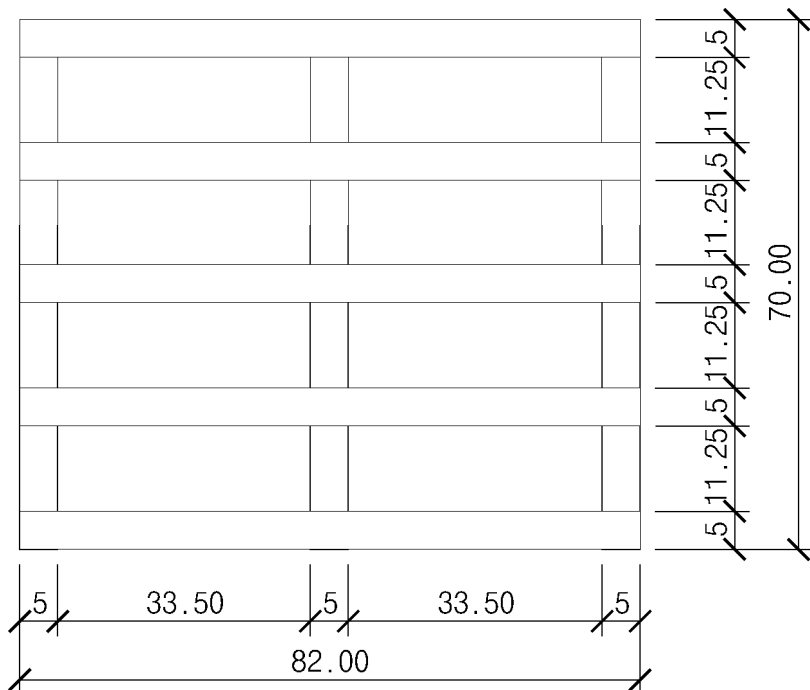

Bokorys palety



Schéma dílů:



Seznam prvků (pro 1 paletu):

Číslo	Profil [mm]	Délka [mm]	ks
-	[mm]	[mm]	-
D1	1x5	82	7
D2	1x5	70	3
D3	1x5	60	3
D4	5x5	7	3
D5	5x5	9	6
P1	-	-	2

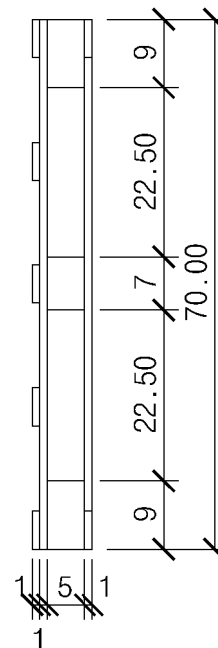
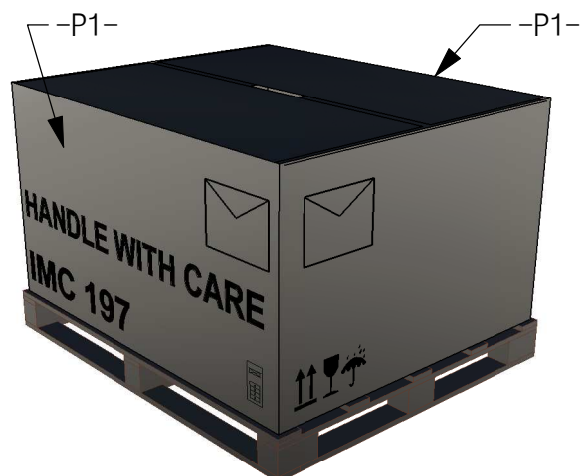
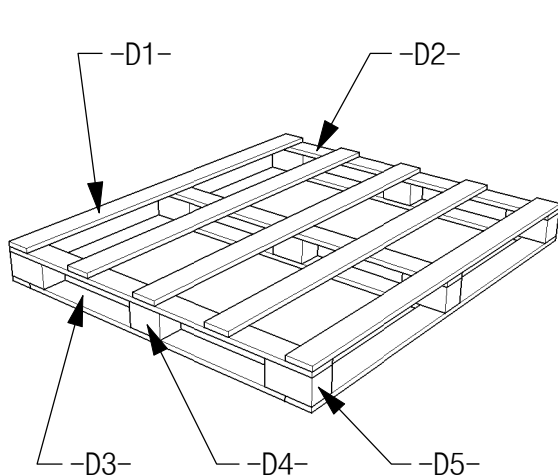
Výpis materiálu (pro 10 palet):

lišta 1x5mm	10ks
lišta 5x5mm	1ks
papír hnědý A4	10ks